

# ThinkSolid™ Modular

## Installation Guide



## Contents

<b>Introduction</b> .....	<b>3</b>
<b>Before you begin</b> .....	<b>4</b>
<b>Storage and preparation</b> .....	<b>4</b>
<b>Tools &amp; materials you may need</b> .....	<b>5</b>
• Adhering your Think Solid™ Modular to your cabinets	
• Joining	
• Appliance cut out preparation	
<b>Getting started</b> .....	<b>5</b>
<b>Cabinet requirements</b> .....	<b>6</b>
<b>Span &amp; overhang support</b> .....	<b>7</b>
• Spans	
• Overhang support	
• External overhang support	
<b>Benchtop sizing &amp; cutting</b> .....	<b>8</b>
• Preparation	
• Join positioning on cabinets	
• Scribing benchtops (if necessary)	
<b>Installing waterfall ends</b> .....	<b>9</b>
<b>Sink &amp; cooktop cut-outs</b> .....	<b>10</b>
• Positioning of appliance template	
• Drilling the radius corners for your cooktop or sink cut out	
• Completing sink and cooktop cutout	
• Sink & appliance fixing blocks	
<b>Joining &amp; installation of benchtops</b> .....	<b>12</b>
• Join preparation	
• Cleaning and preparing joins	
• Positioning the first top	
• Installing the second/third tops	

# Introduction

Welcome to Think Solid™ Modular, proudly brought to you by CASE, a leading supplier of high-quality decorative surface solutions in Australia. Our carefully developed Think Solid™ Modular range is designed specifically to meet the needs of the Australian market. With convenient sizes, installing your new Think Solid™ Modular benchtop has never been easier.

**Superior Design and Durability:** Available in a range of beautiful colours, our benchtops are not only water, chemical, and impact resistant, but also capable of being repaired and restored to their original finish in the rare case of accidental damage. With Think Solid™ Modular, you can enjoy an affordable solid surface solution that combines style, quality, and long-term value.

**Quartz and Crystalline Silica Free:** Rest assured that Think Solid™ Modular is free from quartz and crystalline silica, making it a safe choice for your kitchen or bathroom. Our materials prioritise your well-being while still offering exceptional durability and aesthetic appeal.

**Superior Craftsmanship:** Crafted from natural minerals and polymer resins, Think Solid™ Modular is a 20mm solid surface material. The warmth and inviting feel of our benchtops, which absorb everyday knocks without permanent damage, sets us apart from laminate and other products. Count on Think Solid™ Modular to provide an excellent kitchen benchtop that ensures exceptional hygiene and durability.

**Easy Maintenance:** While Think Solid™ Modular is highly resistant to most kitchen stains, any additional stains can be effortlessly removed with mild abrasive cleaners. It is important to exercise care and avoid scoring with knives or cutting tools, using a chopping board as a protective measure. In the rare event of accidental damage, rest assured that our benchtops can be polished out, or even repaired or renewed if necessary.

**Safeguarding Your Investment:** To ensure the long-lasting beauty of your Think Solid™ Modular benchtop, it is important to avoid subjecting it to high temperatures. Always use a heat pad or trivet when placing hot pots or pans on the surface. For more detailed care and maintenance instructions, please refer to our comprehensive literature.

**Disclaimer:** The information provided in this document serves as a helpful guide for the installation of Think Solid™ Modular. While we strive for excellence, no warranty, whether expressed or implied, is given in relation to the guidelines provided here.

## Before you begin

Please read this booklet before commencing installation of your benchtops. Some of the information may not be applicable to your particular installation, however certain stages of preparation and assembly are important, and spending a short time to review this booklet may save time later.

### Important Notes

1. Installation of the benchtops MUST be carried out by a competent person. If in any doubt, consult an expert on 1300 366 113 for any technical advice.
- 1a. All cabinetry must be level within 2mm maximum.
2. Always carry your benchtop on edge (never flat) (see Fig. 1).
3. Do not rush your installation. Take time and care during installation to achieve a professional finish.
4. Protect your benchtop from damage by keeping all metal tools off the surface during the installation process.
5. Under no circumstances must screws be used directly into the benchtop.
6. When fixing benchtops to cabinets DO NOT use the brackets supplied with your cabinets. Use a silicone adhesive for this purpose.

## Storage & preparation

Installation of the benchtops should be carried out as soon as possible after delivery. If storage is necessary, benchtops MUST be laid flat and fully supported in their original packaging (see Fig. 2). Make sure the storage area is indoors, and in a completely dry area. Do not unpack the benchtops unless the room humidity is stable and all cabinets are installed with any debris cleared away.

To achieve the best installation results, store your benchtops in a room temperature of around 20°C, at least 24 hours prior to installation.

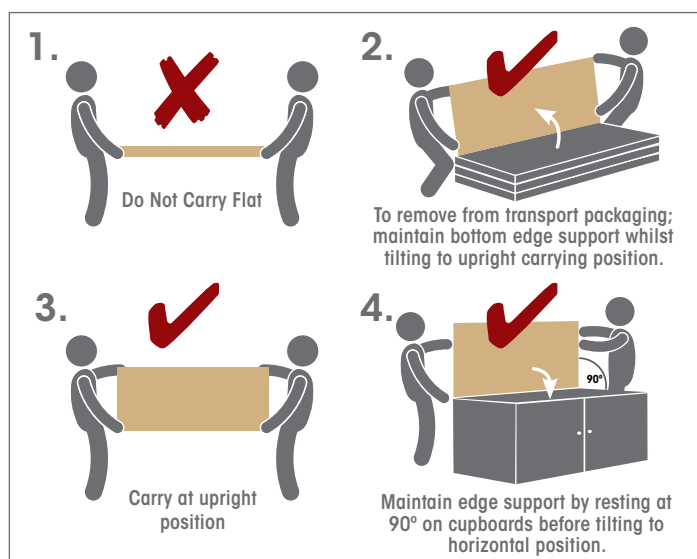

Fig. 1

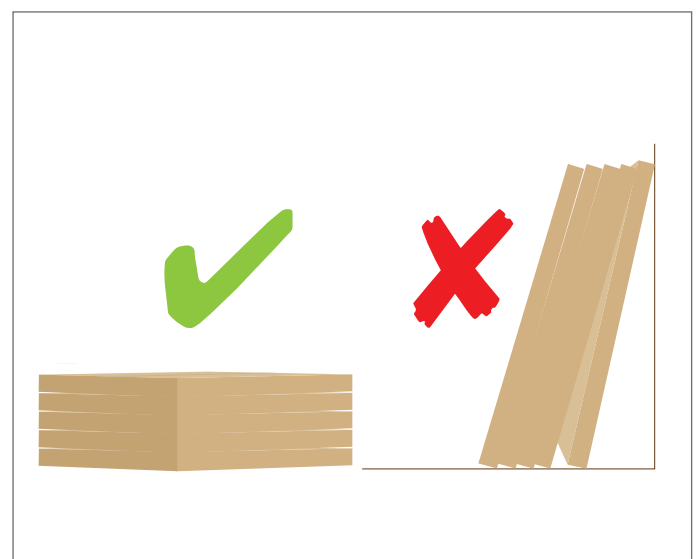

Fig. 2

# Tools & materials you may need

## Adhering your solid surface benchtop to your cabinets

- Tape measure
- Spirit level
- Silicone gun
- Methylated spirits and clean cloth
- Silicone glue
- Straight edge
- Packers or wedges

## Joining

- Sanding block
- Methylated spirits
- Vacuum cleaner
- Face mask
- Safety glasses

## Appliance cut out preparation

- Pencil & square
- Sandpaper (180 grit, to smooth edges of sink and cooktop cut-outs)
- 3M double sided tape as appropriate
- 3M 425 Thermally Conductive Tape (Must be applied to cooktop cutouts)

# Getting started

**CAUTION:** Handle your benchtops with care. Do not place metal tools on the benchtop.

## Checking your cabinets

It is critical in any benchtop installation that the cabinets or structures you intend to fit the benchtops to provide a **level** sturdy foundation. Remove all drawers and doors from the base cabinets and protect the decorative panels etc.

Always work away from a corner and select the correct benchtop component, in conjunction with your kitchen plan.

**Professional Tip** - The operation of sanding and cutting will generate dust. It is recommended to use a face or dust mask and safety glasses when cutting or sanding. It is strongly recommended to use extraction on your power tools to remove the dust, i.e. vacuum cleaner. There will be airborne dust which can only be cleaned after cutting. Sealing doorways etc. to occupied areas is advisable or alternatively do these tasks externally.

## Cabinet requirements (incorporating benchtop support)

Depending on your cabinet configuration and supports, you may need to add additional benchtop support. Using vinyl wrapped hardwood timber, available from Bunnings.

Below are some suggested support modifications.

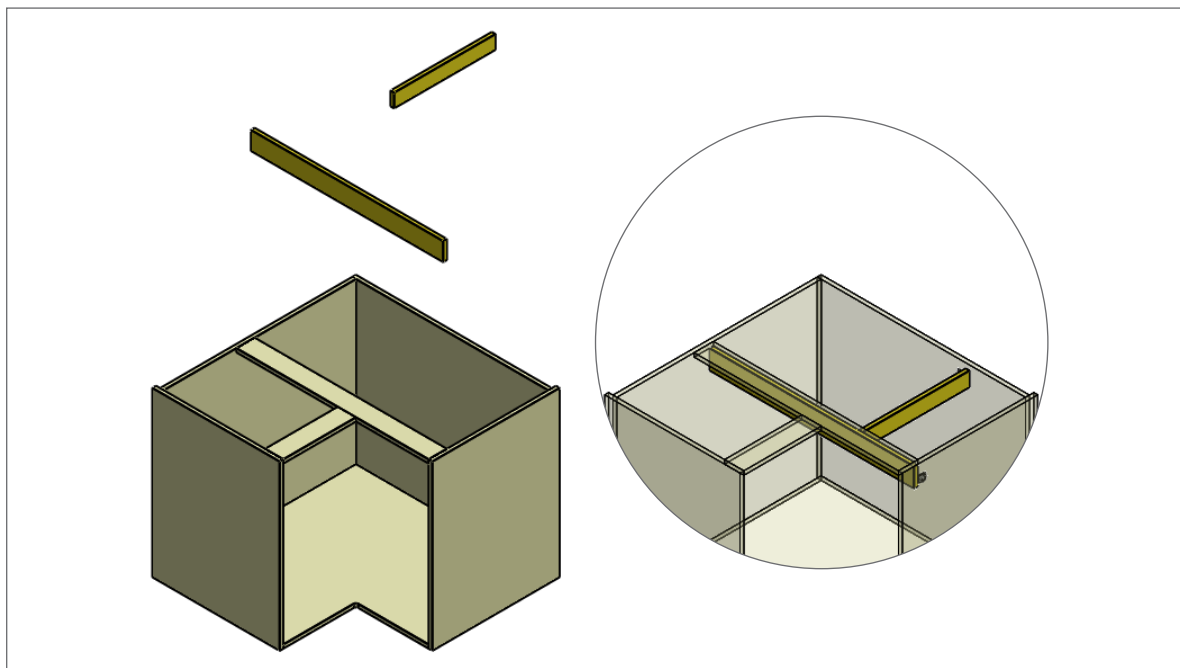
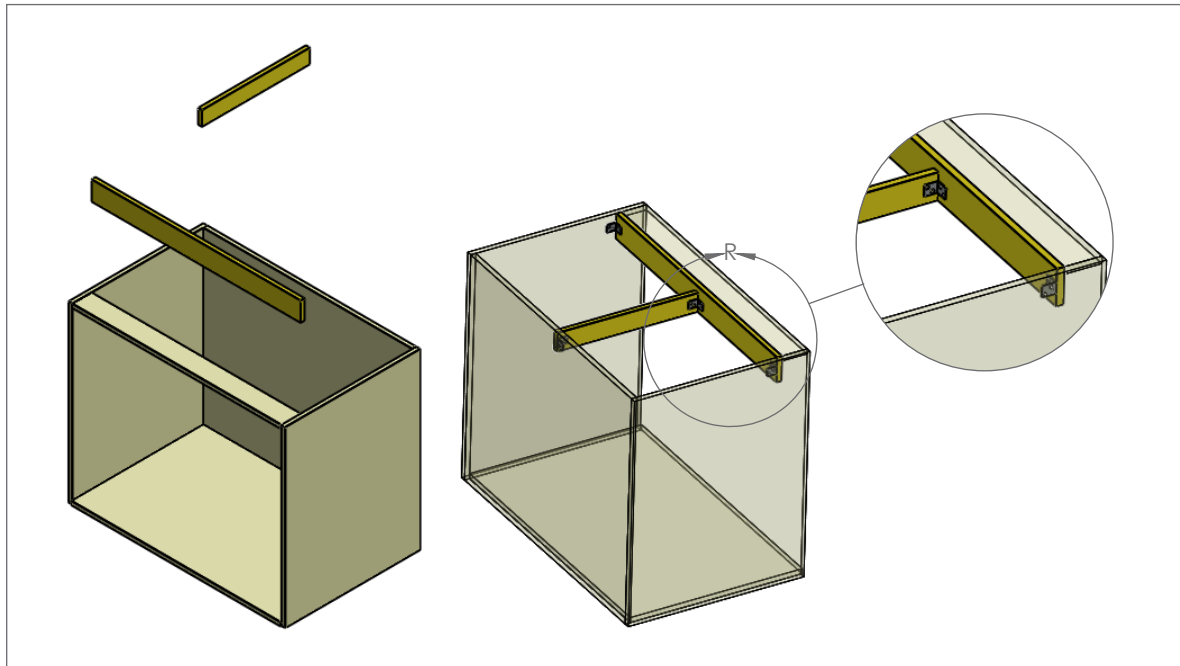

# Span & overhang support

## Spans

Think Solid™ Modular requires a strong perimeter support frame that will keep it level for the useful life of the benchtop. Base cabinets that are spaced 600mm apart provide an ideal base for your Think Solid™ Modular benchtop. If base cabinets exceed 900mm, then additional support material will be required to strengthen these types of installations, ensuring that it provides a strong and level base for the benchtops to be installed.

## Overhang support

Some applications may require a significant benchtop overhang as a functional element or a design feature such as a breakfast bar or island top. The following chart provides guidelines for designing overhanging benchtop sections to ensure adequate support.

Overhang size 20mm material	Suggested support
Less than 150mm	No additional support required
Between 150mm & 300mm	Brackets every 550mm or fixed breakfast bar support legs

We recommend the overhang to be no more than one third of the overall width of the benchtop.

## External Overhang support

If required, support for the benchtop can be achieved using "L shaped" brackets or metal support bars (25mm x 25mm x 2mm Square Hollow Section Steel). Support to be placed every 500/550mm along the length of the overhang and within 250mm at both exposed ends. SHS bar must extend into cabinet cavity as marked to provide load spread. Professional Tips: Cleats on wall can be used for overhang support where peninsular/island butts into wall.

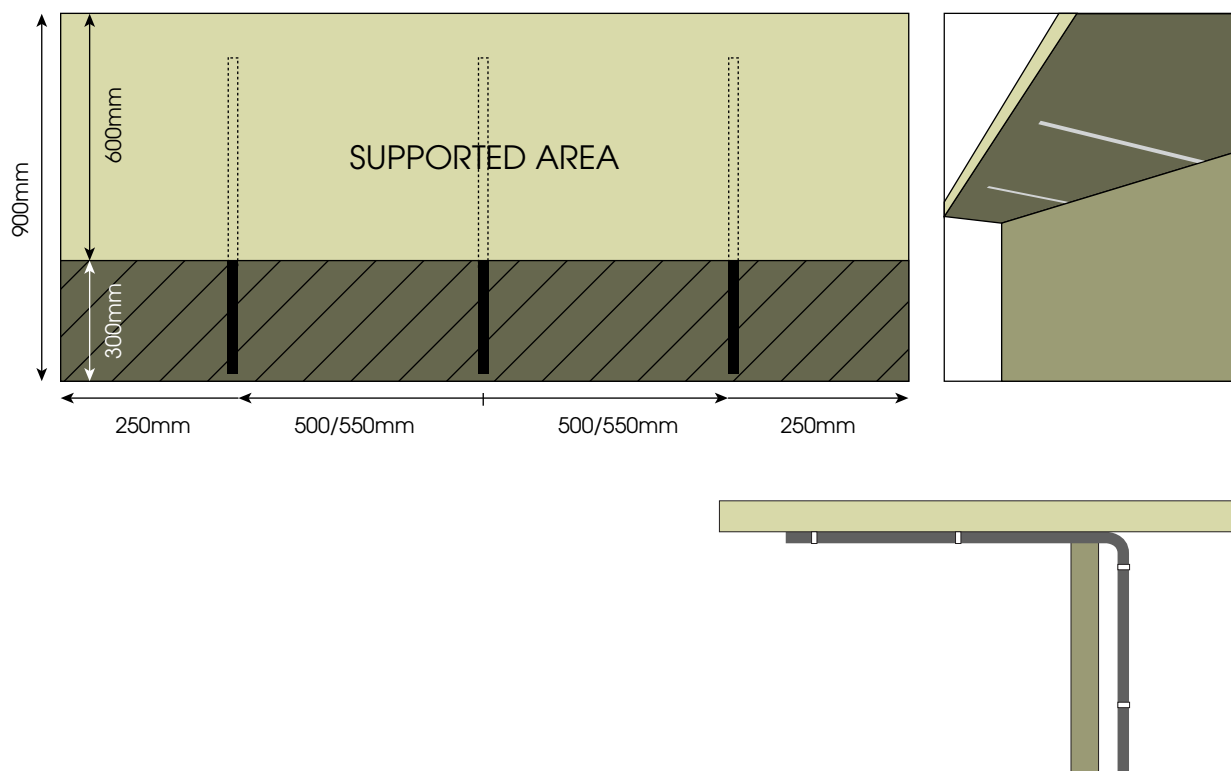

## Benchttop sizing & cutting

### Preparation

- Always cut so the join sits on the cabinet end panel of the cabinet wherever possible (Fig. 3), enabling benchtops to be joined on a gable end not in the middle. This gives added support to a join and a stronger area for shimming up the surface to achieve a flush join. Where this isn't possible an MDF strip (90x25mm) should be secured below the join to give added support.
- Ensure benchtops get an expansion clearance between walls of 1mm for every linear metre of benchtop (i.e. 3mm for 3 metre length).
- Ensure all benchtop joins are a minimum of 150mm away from any appliance cut-out.
- Any cutting work should be done outside as machining Think Solid™ Modular creates dust.

### Join positioning on cabinet ends

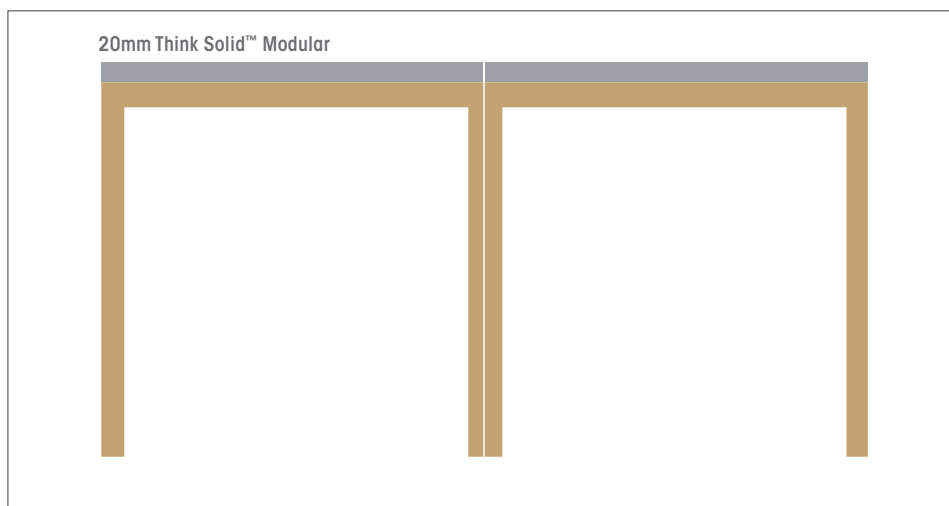

Fig. 3 Recommended position



## Scribing benchtops (if necessary)

The scribing process (Fig. 4) reflects the contours of the wall, not the benchtop and is achieved by placing a small block of wood onto the surface and against the wall.

Always remember to add 30-35mm overhang to carcass, which will take into account the door thickness, and also make sure the thickness of any waterfall ends (if applicable) is taken into account. Adhere a strip of 50mm masking tape flush with the back edge of the benchtop, this will enable you to see the pencil line that will be produced in the scribing process. A pencil is then placed at the front edge of the block. The block and pencil are then pushed along the length of the benchtop, marking the benchtop as you proceed. Using this method, any deviation in the wall is marked onto the benchtop.

Scribe with a router.

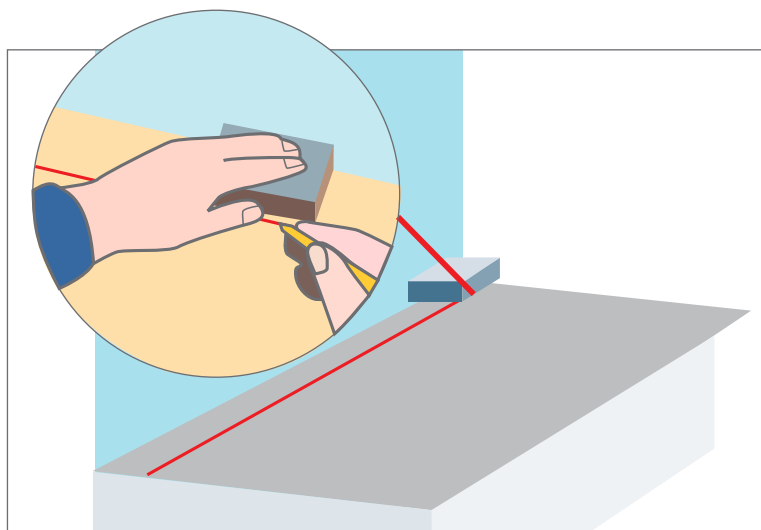
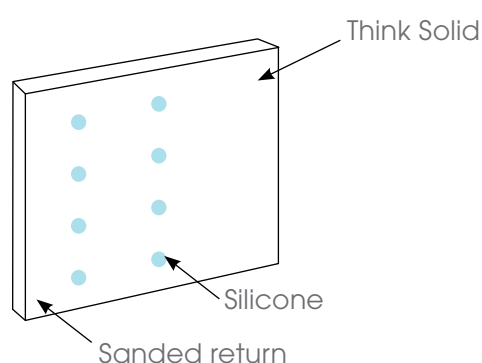

Fig. 4 Scribing to correct depth

## Installing waterfall ends – 20mm

Position the waterfall end, and dry fit. Pack up from the floor, make sure everything is square, dry fit benchtops to make sure everything is in the correct position.

To install the waterfall end, dab silicone adhesive at 250-300mm intervals, where the cabinet to waterfall end connect.



## Sink & cooktop cut-outs

### Step 1 – Positioning of appliance template

The use of a sharp hole saw and track saw is one of the most essential elements to the successful completion of a sink or cooktop cutout in your Think Solid™ Modular benchtop.

- Apply masking or painters tape to benchtop where the appliance is to be positioned. (see Fig. 5)
- Measure and overlay appliance manufacturers paper template onto the masking tape area.
- Tape the template to the area to secure in place while you carefully trace around the template with a marker. (see Fig. 6)

### Step 2 – Drilling the radius corners for your cooktop or sink cut out

Ensure you use the appropriate diameter of hole saw to match the radius corner of your sink or cooktop appliance.

- **CAUTION:** Ensure you operate these power tools according to the manufacturer's instructions. Consult an expert if you have any doubt.
- Using the appropriate hole saw diameter bit, drill the four corners of the cooktop/sink cutout
- Ensure the benchtop is properly supported before you commence cutting the cut-out, making sure the waste part of the benchtop is supported at all times. (see Fig. 7)
- **CAUTION:** Failure to properly support the waste section of the cut-out will cause damage to your benchtop.
- **CAUTION:** A jig-saw should not be used to make the cut-out in the Think Solid™ Custom material.

### Step 3 – Completing sink and cooktop cutout

- Using a track saw cut the two long sides.
- Once completed, hot melt glue fix a piece of timber across the cutout. (see Fig. 7)
- Using the track saw, complete the two short sides of the cut out. (see Fig. 8)
- Remove the cutout piece.
- **CAUTION:** Failure to properly support the waste section of the cut-out will cause damage to your benchtop.
- **CAUTION:** A jig-saw should not be used to make the cut-out in the Think Solid™ Custom material.

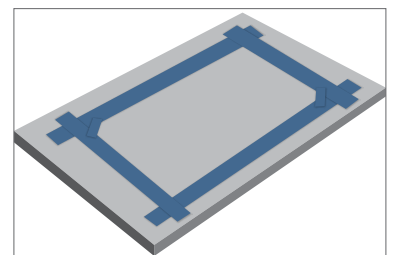

Fig. 5

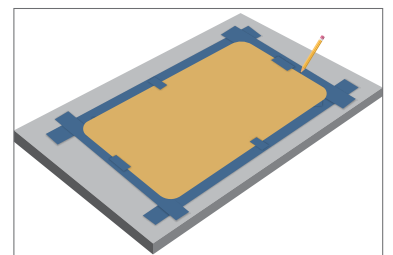

Fig. 6

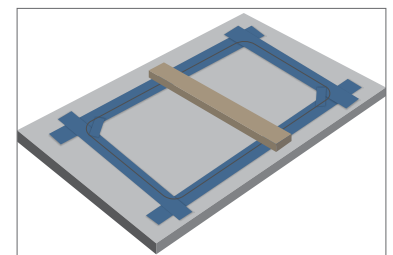

Fig. 7

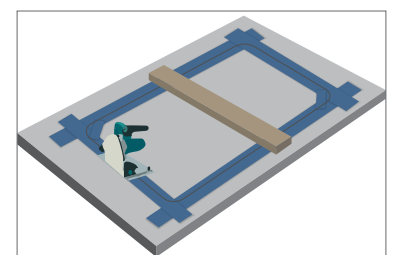

Fig. 8

- Using a 180 grit sandpaper, sand the inside edge of the cut-out to remove cutting marks. (see Fig.9)
- Remove sharp edges at the top and bottom of the cut-out by sanding the edges to an approx. 2mm radius. This can be done with 180 grit sand paper and block. **If this is not done correctly, fine cracks may appear in your benchtop over a period of time.**
- **For cooktop cut-outs only, apply the 3M thermally conductive tape around the cut-out in one continual piece. This is an important step to ensure the benchtop is protected from excessive heat**
- Ensure the aluminium heat tape extends up the cutout edge and over the surface of the benchtop enough to run past the outside edge of the cooktop flange. (see Fig. 10)

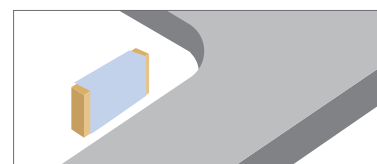

Fig.9

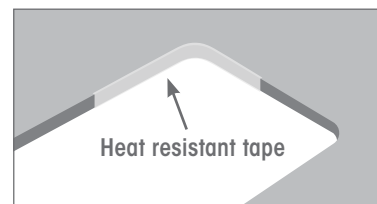

Fig.10

**Professional Tip** - Ensure all benchtop joins are a minimum of 150mm away from any appliance cut-out

**Professional Tip** - After properly finishing the edges of the off cut of your sink or cooktop cut out, apply four rubber feet under the surface and use this as a colour matched heat pad in your kitchen.

## Step 4 - Sink & appliance fixing blocks

**Important Note:** All sink and appliance fixing blocks must be bonded in position before any benchtops are joined or fixed in place.

When installing a sink or appliance, ensure that no screws are used directly into the Think Solid™ Modular benchtops. In some installation scenarios it may be necessary to bond additional fixing blocks (eg. MDF, plywood, particle boards) to the underside of the benchtops.

### Undermounting your sink (if required)

Please note, if you intend to undermount your sink, you will need to position and fix the sink to the underside of the benchtop prior to the benchtop being installed on to the cabinets.

The following steps will prove helpful to achieve the best results when mounting your sink.

**Step 1** Ensure you use the installation instructions provided by your sink manufacturer to obtain the best results.

**Step 2** Ensure you locate the exact position of where you require your sink to be cut-out. Refer to the steps above in this installation guide for help.

**Step 3** Once the hole is cut, sand the inside edge of the cut-out smooth with a 180 grit sandpaper, making sure you remove all cutting marks.

**Step 4** Remove sharp edges at the top and bottom of the cut-out by sanding the edges to an approx. 2mm radius. If this is not done correctly, fine cracks may appear in your benchtop over a period of time.

**Step 5** Turn the benchtop over and locate where to position any additional fixing blocks. Refer to "Sink & Appliance fixing blocks" section in this installation guide.

**Step 6** Remove all dust or dirt around the underside of the cut-out. Apply a bead of silicone to the underside of the sink cut-out and position the sink under the benchtop.

**Step 7** Tighten the sink mounting screws to the timber subframe and any fixing blocks. Remove any excess silicone that oozes around the edge as per the manufacturer's instructions.

**Step 8** Once you have installed the sink, turn the benchtop over to complete the overall benchtop installation. Refer to the "Joining and Installation of Benchtops" section of this installation guide.

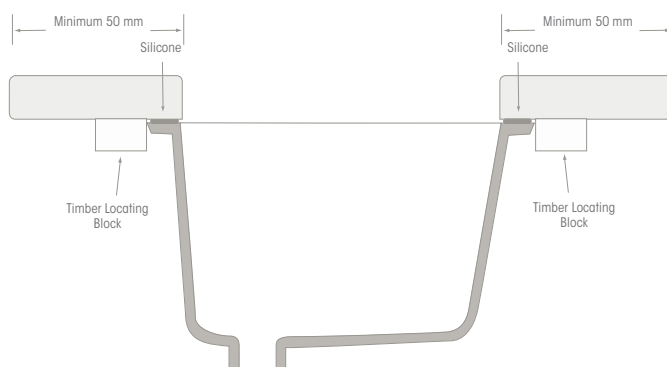

## Joining & installation of benchtops

### Step 1 - Join preparation (Dry Fitting)

After all cut-outs have been made, dry fit the pieces together to double check the alignment and fit. Also make sure the tops are level.

**Note:** Ensure the edges which are joining meet along the full length (see Fig. 11). When levelling and benchtops are butted together they can be shimmed underneath with thin packing pieces (not supplied). Avoid packing if it is greater than 2mm. Level cabinet within 2mm before proceeding.

**Note:** Properly leveled joints allow a better quality finish.



Fig.11

### Step 2 - Cleaning and preparing joins

Clean the pre-prepared edges with methylated spirits prior to applying the translucent silicone. Ensure your hands are clean to avoid contamination of the silicone in the join.

### Step 3 - Positioning the first top

Start in a corner and work outwards. Apply small amounts of the translucent silicone sealant on the cabinet front & back rails, as well as other points where they make contact with the benchtops. (see Fig. 12). Gently fit the first top in place and check that it is level in both direction; lineal & axial (see Fig. 13).

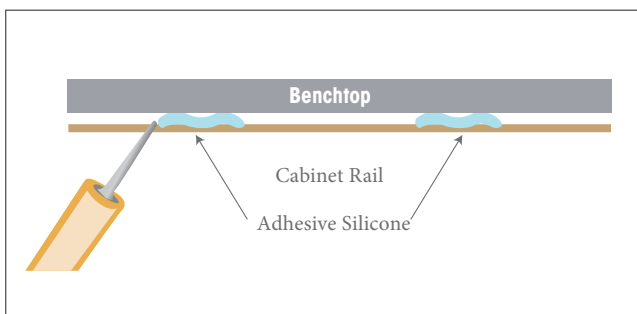

Fig.12

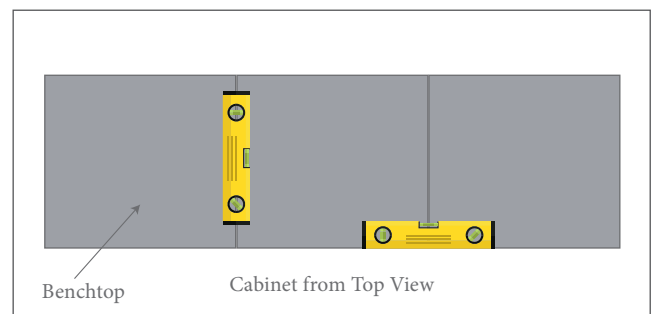

Fig.13

## Step 4 – Installing the second/third tops

Apply translucent silicone sealant to the cabinets as before in Step 3.

### Joining the benchtops together

**CAUTION: Ensure hands are clean** so as not to contaminate the silicone in the joint.

Apply a bead of translucent silicone sealant along the adjoining edges. (see Fig. 14) Bed the benchtop down onto the sealant and push the benchtops together ensuring they are aligned, and join firmly ensuring that a small amount of silicone sealant beads on the benchtop surface. (see Fig. 15).

Remove any excess translucent silicone sealant from the benchtop with a clean, moist cloth.

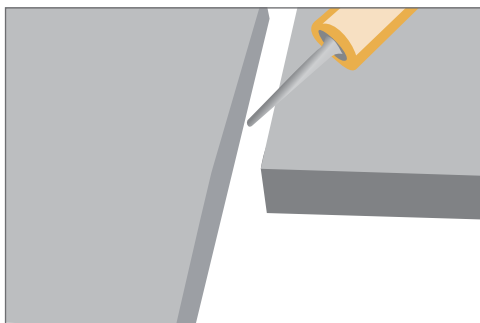

Fig. 14 Butt Join

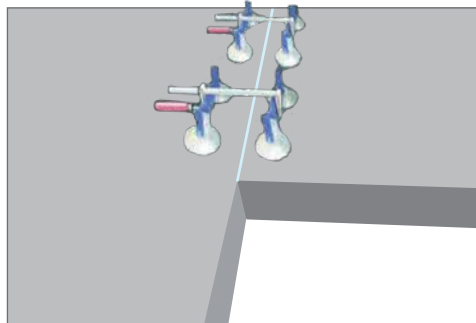

Fig. 15

Once you have completed the installation of all benchtops, you can have your appliances installed by a licenced plumber and/or electrician.

**Professional Tip** – Under no circumstances should screws be fixed directly into Think Solid™.

**Professional Tip** - Installation of the benchtops that have in excess of a 150mm overhang (e.g. Breakfast bars) will require additional support. Use of appropriate brackets is recommended to properly support these benchtops. See Span & Overhang support for more details.

**Important** – 2/3rds of benchtop must be supported by cabinets at all times. ie. Max benchtop overhang is 1/3 of overall benchtop depth.

---

---

**FOR MORE INFORMATION,  
PLEASE CONTACT CASF  
1300 366 113  
[thinkbentops@casf.com.au](mailto:thinkbentops@casf.com.au)**